



COMF ELECTRONIC COMPANY

EXPORTERS, IMPORTERS & MANUFACTURERS

香港九龍灣臨興街32號 美羅中心1期 15樓11室

Flat 11, 15/F., METRO CENTRE 1, 32 LAM HING ST.,

KOWLOON BAY, HONG KONG

TEL: (852) 2770 5181

FAX: (852) 2798 8129



WEB: www.comf-hk.com

Email: sales@comf-hk.com

Product Data Sheet

SBH-321-1A

Specification

Cell Size:	2 X AA Cell, UM-3
Wire:	AWG 26, UL1007 150mm ± 5mm Stripped and Tinned: 5mm ±1mm
Body:	ABS 94HB, Black
Terminals:	Nickel plated brass
Springs:	Ø0.6mm Nickel plated 65C spring steel
Compliance:	  



SBH-321-1AS Shown without leads

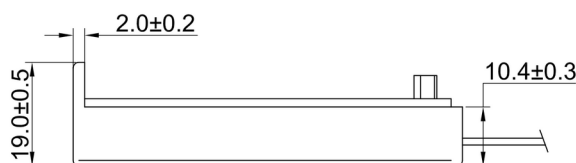
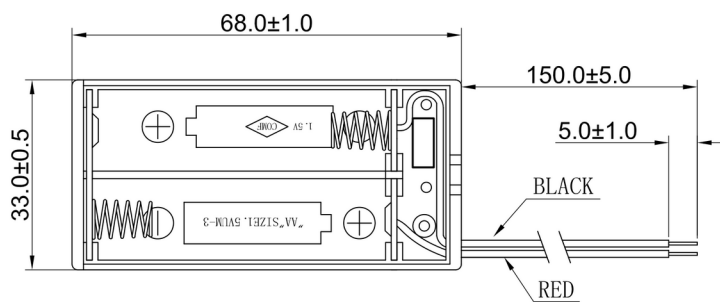

BOTTOM

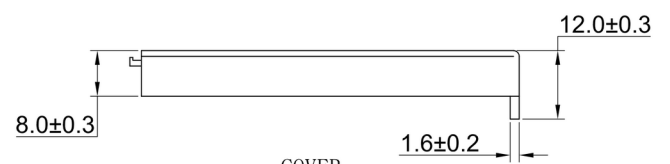
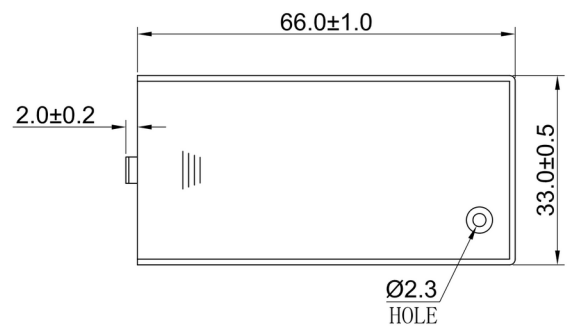

COVER