



COMF ELECTRONIC COMPANY

EXPORTERS, IMPORTERS & MANUFACTURERS

香港九龍灣臨興街32號 美羅中心1期 15樓11室

Flat 11, 15/F., METRO CENTRE 1, 32 LAM HING ST.,

KOWLOON BAY, HONG KONG

TEL: (852) 2770 5181

FAX: (852) 2798 8129





WEB: www.comf-hk.com

Email: sales@comf-hk.com

Product Data Sheet

BH-441B

Specification

Cell Size:	4 X AAA Cell, UM-4 With Polarity Protection
Body:	Polypropylene, 94HB Black
Link Wire:	26AWG UL1007
Terminals:	Nickel plated brass
Springs:	Ø0.6mm Nickel plated 65C spring steel
Compliance:	   



BH-441A Shown Without Leads

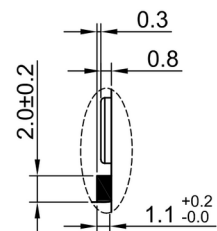
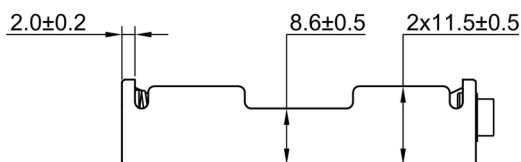
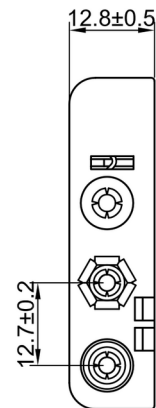
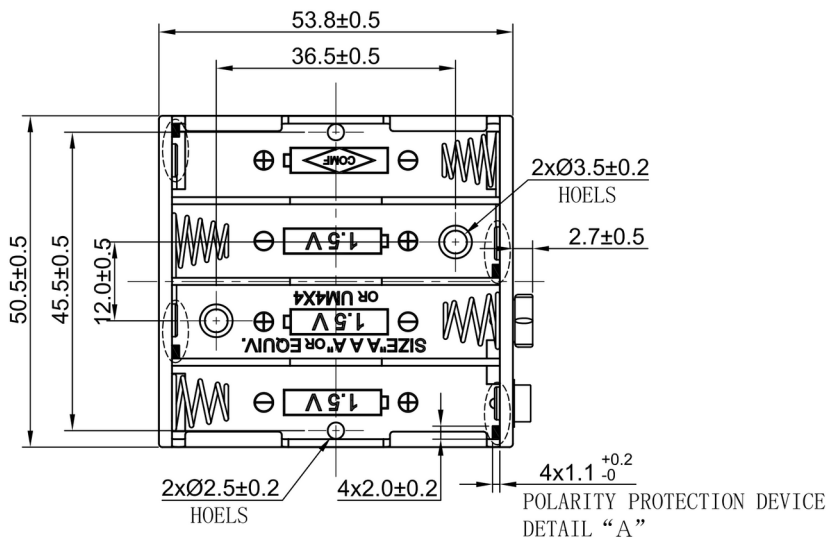

POLARITY PROTECTION DEVICE DETAIL "A" S=2